

GLOBAL SENSITIVITY ANALYSIS IN STABILITY PROBLEMS OF STEEL FRAME STRUCTURES

Zdeněk KALA

*Department of Structural Mechanics, Faculty of Civil Engineering, Brno University of Technology,
Veveří str. 95, 602 00, Brno, Czech Republic*

Received 04 Jun 2015; accepted 06 Jul 2015

Abstract. Slender steel frame structures are characterised by a number of imperfections which may reduce their load carrying capacity drastically. This article studies the effects of these imperfections on the load carrying capacity of a single storey steel plane frame using global sensitivity analysis and geometrically nonlinear (second-order) elastic finite element analysis. Imperfections are considered as random variables. Statistical load carrying capacities needed for the evaluation of sensitivity analysis are processed using classical statistical methods upon the emulation of Latin Hypercube Sampling simulation methods. The main interaction effects of random imperfections on the load carrying capacity are identified using global sensitivity analysis. It is illustrated that the effects of imperfections on the load carrying capacity varies dramatically depending on the height of the columns and the boundary conditions of the end conditions of the columns.

Keywords: steel, frame, reliability, stability, sensitivity, failure, column, buckling, imperfections.

Introduction

The reliability of frame structures is generally affected by a number of imperfections. In global frame analysis, the pattern of initial imperfections is often chosen to be the worst case scenario to maximize their destabilizing effects under the applied loads (Shayan *et al.* 2014).

The great significance of initial imperfections for the reliability of slender steel structures has led to the proposal of a number of approaches of their modelling, and to the development of numerous computational models that are focused on the nonlinear behaviour, displacements and load carrying behaviour (Bažant, Cedolin 1991). Chan and Zhou (1995) proposed a method which considers the effects of initial imperfections on the element stiffness matrix of the column. Xu and Wang (2008) performed parametric studies on the effects of initial imperfections and out-of-plumb on the lateral stability of unbraced plane frames. Shayan *et al.* (2014) used advanced nonlinear analysis to investigate the influence of random geometric imperfections as a linear combination of scaled eigenmodes on the strength of steel frames. Nagyová and Ravinger (2012) showed the possibility of identifying initial imperfection of column using nonlinear analysis of the natural frequency. Dario Aristizabal-Ochoa (2013, 2015) studied the effects of initial imperfections on stability, and carried out geometrically nonlinear analysis of

columns and frames with semi-rigid connections. Zhang *et al.* (2010) investigated the effects of random imperfections on the ultimate strength of multi-storey steel scaffold frames. Agüero *et al.* (2015) studied the nonlinear effect of imperfections on the load carrying capacity of frames, and proposed the application of the strain energy method to the estimation of the worst imperfection directions with consideration to external load.

In reality, all initial imperfections are random, and a rational modelling of imperfections can only be achieved by using probabilistic methods (Shayan *et al.* 2014). The application of probabilistic methods to the evaluation of reliability of frames presents a new set of problems, particularly in identifying the statistical characteristics of initial geometric imperfections (Kala 2011a). Sufficient information from experiments is usually available for the imperfections of standardized and mass-produced single columns (Melcher *et al.* 2004; Kala *et al.* 2009). The modelling of geometric imperfections is much more complicated for a frame (Kala 2011a, 2011b) than for a single column (Kala 2009, 2015) because the collection of statistical data of imperfections carried out on ample frame samples is practically impossible.

Sensitivity analysis is used to study the effects of random imperfections on the load carrying capacity of the frame depicted in Figure 1. Imperfections are respon-

sible for the failure of real frames far below the buckling load of an idealized perfect frame. Sensitivity analysis is the process of determining how changes in model input imperfections or assumptions (including boundary conditions) affect the model outputs (Saltelli *et al.* 2004). The frame was solved with two variants of column end conditions, see Figure 2.

The effects of initial random imperfections on the load carrying capacity, which was obtained using the geometrically nonlinear analysis with beam elements (Kala 2012), were studied using sensitivity analysis. Sensitivity coefficients were evaluated in dependence on the frame height h , which was considered as the analysis parameter.

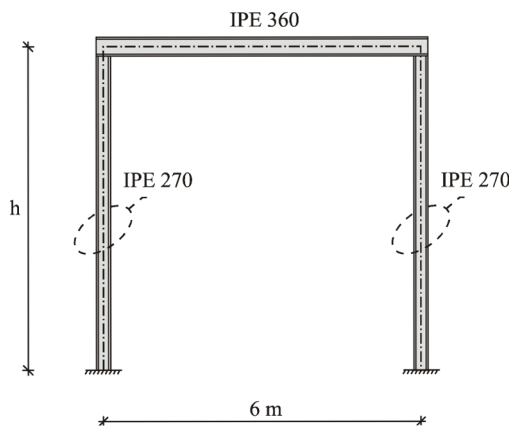

Fig. 1. Steel frame geometry

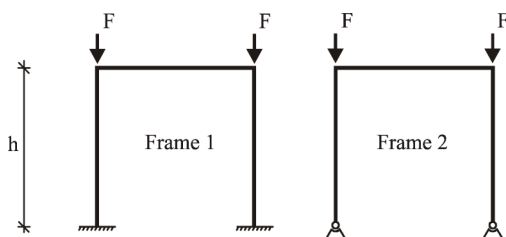

Fig. 2. Steel frame column end variants

1. Initial imperfection

System geometric imperfections were introduced into the structural models as scaled eigenmodes obtained a priori from an elastic buckling analysis, see Figure 3. The amplitude e_0 of the assumed eigenmode can be calibrated according to empirical maximum imperfection values determined by experimental tests or numerical sensitivity studies. The amplitude e_0 must not exceed the tolerance limits usually specified in standards as out-of-plumb or out-of-vertical imperfections.

Tolerance limits indicate the degree of safety and reliability which we require for the structure to be constructed. European standard (EN 1090-2:2008+A1:2011 2011) considers the tolerance interval $\pm h/500$ for e_0 , which in current practice is the commonly considered tolerance, based on traditional practice across Europe and beyond (Dario Aristizabal-Ochoa 2013, 2015; Ken-

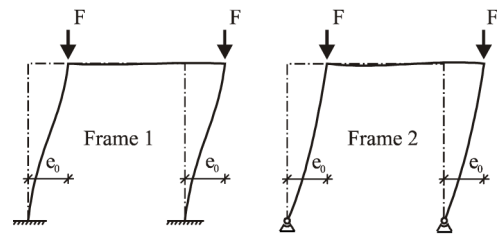

Fig. 3. Buckling of Frame 1 and Frame 2

nedy *et al.* 1993). It was assumed that the amplitude e_0 would be found in the interval $\pm h/500$ with 95% probability (Kala 2011a; Melcher *et al.* 2004). Gauss probability density function with mean value of zero (ideally vertical column) and corresponding standard deviation $h/1000$ was considered for random variable e_0 (Kala 2008), see Figure 3. These statistical characteristics are in relatively good concordance with research results (Beaulieu, Adams 1977), where the out-of-plumb of 916 columns was measured in two horizontal directions and reported the mean as almost zero and the standard deviation as 0.00162.

The first eigenmode shape of buckling usually suffices for the modelling of imperfections in computational models aimed at the static analysis of frames (Kala, Puklický 2009). A more detailed analysis can be carried out by modelling the initial out-of-plumb and bow imperfections of the columns as four random variables (Kala 2011b).

Both columns and the cross beam of the steel plane frame are made from standardized hot-rolled European members IPE 270 and IPE 360, see Figure 4. h is cross section height, b is cross section width, t_w is web thickness, t_f is flange thickness. Figure 4 depicts the nominal geometric characteristics of IPE members, which however, in production can only be adhered to approximately with a certain precision. Measurements of the imperfections of the IPE sections were obtained from long-term experimental research (Melcher *et al.* 2004; Kala *et al.* 2009). Cross section geometrical characteristics are used to calculate the cross sectional area and the second moment of area around axis y ; these are the input parameters for the computational model.

The yield strength, ultimate tensile strength, ductility data and geometrical characteristics of hot-rolled steel

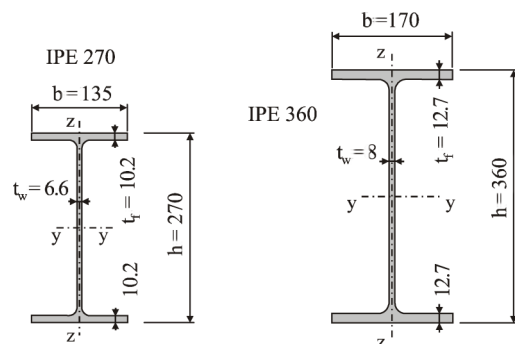

Fig. 4. Nominal geometry of cross-section of IPE

beams are the most important material characteristics which have been studied experimentally during long-term research work (Melcher *et al.* 2004; Kala *et al.* 2009).

IPE beams are produced from steel S235, where S235 is the designation of European structural steel, whose nominal yield strength listed in standard (EN 1993-1-1:2005 2005) is 235 MPa. 235 MPa should approximately correspond to five percent quantile, which should guarantee sufficient reliability of design (EN 1993-1-1:2005 2005). Statistical characteristics of yield strength f_y of steel grade S235 were determined from 596 samples taken from one third of the flange. The mean value was 297.3 MPa, and standard deviation 16.8 MPa, see Table 1. The measured values (Melcher *et al.* 2004) were, with satisfactorily high probability, higher than the standard characteristic value 235 MPa given in the standard (EN 1993-1-1:2005). Statistical characteristics of Young's modulus E were considered according to Soares (1988).

Table 1. Input random imperfections

No.	Member	Symbol		Mean value	Std. Deviation
1.	Left Column	h_1	*	270.27 mm	1.196 mm
2.		b_1	*	135.82 mm	1.341 mm
3.		t_{w1}	*	6.963 mm	0.276 mm
4.		t_{f1}	*	10.129 mm	0.467 mm
5.		f_{y1}	**	297.3 MPa	16.8 MPa
6.		E_1	*	210 GPa	12.6 GPa
7.	Cross Beam	h_0	*	360.36 mm	1.595 mm
8.		b_0	*	172.29 mm	1.689 mm
9.		t_{w0}	*	8.44 mm	0.335 mm
10.		t_{f0}	*	12.61 mm	0.582 mm
11.		f_{y0}	**	297.3 MPa	16.8 MPa
12.		E_0	*	210 GPa	12.6 GPa
13.	Right Column	h_2	*	270.27 mm	1.196 mm
14.		b_2	*	135.82 mm	1.341 mm
15.		t_{w2}	*	6.963 mm	0.276 mm
16.		t_{f2}	*	10.129 mm	0.467 mm
17.		f_{y2}	**	297.3 MPa	16.8 MPa
18.		E_2	*	210 GPa	12.6 GPa
19.	System	e_0	**	0	h/1000

Note: * Histogram, ** Gauss density function.

Table 1 lists the mean values and standard deviations of the histograms of initial geometric and material imperfections of steel frames 1 and 2. Statistical correlations among imperfections listed in Table 1 are considered with the value of zero.

2. Computational model

The geometrically nonlinear computational finite element model developed by the author of the presented article was utilized (Kala 2012). Meshing of the frame geometry was carried out using beam elements. The columns were meshed with 20 elements each. The cross beam was meshed by 10 elements. The stiffness matrix of the beam element and the nonlinear step by step solution were published in detail in Kala (2012). Analysis is performed on the basis of perfect elasticity of the material.

Furthermore, shear deformations are neglected. The load carrying capacity was obtained using the combination of the nonlinear Euler incremental method with the Newton–Raphson method.

Criterion (i) for the load carrying capacity is given by the load during which plasticization of the flange starts. Criterion (ii) for the load carrying capacity is given by the load that corresponds to the reduction of tangential toughness determinant to zero. Criterion (ii) is applied sporadically, when the Monte Carlo realizations e_0 are arbitrarily small and, at the same time, the realizations of yield stress of both left and right column are extremely high. The ultimate one-parametric loading is given as the minimum of load carrying capacities (i) and (ii) (Kala 2012).

3. Sensitivity analysis

Sensitivity analysis problems are different in nature, hence different techniques have been proposed for their solutions (see, e.g. Saltelli *et al.* 2004). Regarding issues of reliability in the building industry, sensitivity analysis is a significant part of reliability analysis of geotechnical tasks (Marčić *et al.* 2013), masonry systems (Sousa *et al.* 2015), concrete structures (Yang 2007), and steel structures (Kala 2011b; Kamiński, Świta 2014). Sensitivity analysis can be also a significant component of multi-criteria decision-making techniques for sustainable building assessment (Siozinyte, Antucheviciene 2013; Prasad *et al.* 2015; Antucheviciene *et al.* 2015).

The consistent concept of sensitivity analysis as a tool for the analysis of the effects of arbitrary subgroups of input factors (doubles, triples, etc.) on a monitored output was elaborated by mathematician Ilja M. Sobol' (Sobol' 1993, 2001). Sensitivity analysis of the load carrying capacity (random output Y) to input imperfections (random inputs X_i) was performed according to Eqns (1), (2) and (4) in the presented study.

Sobol's first order sensitivity indices may be expressed as (Saltelli *et al.* 2004):

$$S_i = \frac{V(E(Y|X_i))}{V(Y)}. \quad (1)$$

S_i is a measure of the first order (e.g. additive) effect, i.e. the main effect, of X_i on the model output Y . The sum of all S_i is equal to 1 for additive models, and less than 1 for non-additive models. The difference $1 - \sum_i S_i$ is an indicator of the presence of interactions in the model.

The interaction term between factors X_i, X_j is expressed by index S_{ij} :

$$S_{ij} = \frac{V(E(Y|X_i, X_j))}{V(Y)} - S_i - S_j. \quad (2)$$

S_{ij} measures the second order (two-way) effect of X_i, X_j on the model output Y . It describes the part of the response of Y to X_i, X_j that cannot be expressed as a superposition of effects separately due to X_i and X_j .

Sensitivity indices of other higher orders can be expressed analogously (Saltelli *et al.* 2004). Interaction terms reaching the order k may exist for a computational model with M factors (i.e. Saltelli *et al.* 2004):

$$\sum_i S_i + \sum_i \sum_{j>i} S_{ij} + \sum_i \sum_{j>i} \sum_{k>j} S_{ijk} + \dots + S_{123\dots M} = 1. \quad (3)$$

It is neither common nor practical to evaluate all $2^M - 1$ sensitivity indices in Eqn (3). Let us remark that Eqn (3) has 524287 indices due to nineteen imperfections in Table 1. However, the values of the sensitivity indices of the third and higher orders are very small. It is therefore possible and sufficient to evaluate only Eqns (1), (2) and the total order sensitivity indices S_{Ti} (Eqn (4)). The total order sensitivity index S_{Ti} measures the total effect of a factor, including its first order effect and interactions of any order (Saltelli *et al.* 2004):

$$S_{Ti} = 1 - \frac{V(E(Y|X_{-i}))}{V(Y)} = \frac{E(V(Y|X_{-i}))}{V(Y)}, \quad (4)$$

where: $V(Y|X_{-i})$ – the conditional variance of output random variable evaluated for input random variable X_i and fixed variables ($X_1, X_2, \dots, X_{i-1}, X_{i+1}, \dots, X_M$); $E(V(Y|X_{-i}))$ – the arithmetical mean of this variance which is evaluated for (non-fixed) input random variables ($X_1, X_2, \dots, X_{i-1}, X_{i+1}, \dots, X_M$). The difference $S_{Ti} - S_i$ expresses the degree of involvement of X_i in interactions with other input factors.

A highly efficient sampling method, Latin Hypercube Sampling (LHS) (McKey *et al.* 1979; Iman, Conover 1980), was applied to generate input random variables. The output Y is the random load carrying capacity. The load carrying capacity was obtained with an accuracy of 0.1 percent in each simulation run.

The procedure of calculation of the LHS method can be explained practically on the evaluation of the first order sensitivity indices (Eqn (1)). Afterwards K realizations of vector X_{-i} (apart from the i_{th} one), i.e. $X_{-i}(j, 1), \dots, X_{-i}(j, K)$ were generated for each realization $X_i(j), j = 1, \dots, N$. Let us remark that K can, but need not, be equal to N . Furthermore $E(Y|X_i)$ is determined for every single j :

$$E(Y|X_i) \approx m(j) = \frac{1}{K} \sum_{k=1}^K f(X_i(j), X_{-i}(j, k)). \quad (5)$$

The value $V(E(Y|X_i))$ can be approximately determined from the relation:

$$V(E(Y|X_i)) \approx \frac{1}{N-1} \sum_{j=1}^N (m(j) - \bar{m})^2, \quad (6)$$

where \bar{m} is an assessment of arithmetical mean:

$$\bar{m} = \frac{1}{N} \sum_{j=1}^N m(j). \quad (7)$$

$N = K = 10000$ simulation runs of the LHS were used in the presented study. The variance $V(Y)$ was evaluated

from one million runs of the LHS method with consideration of the variability of all imperfections from Table 1. Indices S_{ij} and S_{Ti} were calculated using the same numerical means in a similar manner as the sensitivity index S_i .

4. Sensitivity analysis results

Sensitivity analysis results of both frames are displayed using pie charts. 360° represents the sum of 1 (Eqn (3)). All first-order (Eqn (1)) and second-order (Eqn (2)) sensitivity indices were evaluated. The sum of other higher-order indices were then calculated as the difference obtained upon subtraction from Eqn (1), see black slice of the pie chart (Fig. 5).

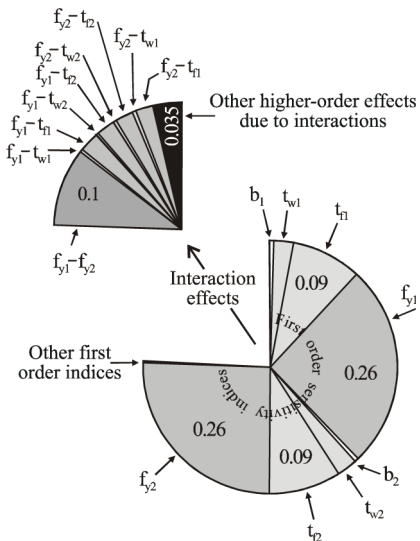

Fig. 5. Sensitivity analysis – Frame 1 and/or 2, $h = 0$ m

If $h = 0$ m, then results of the sensitivity analyses are the same for both frames and may be represented using one pie chart (see Fig. 5). It may be remarked that the same results of sensitivity analysis are obtained for a frame with columns subjected to tension as it was obtained for $h = 0$.

It is apparent from the chart in Figure 5 that the first-order effects are crucial, the second-order effects are secondary. The load carrying capacity is most influenced by the yield strength of the left column, right column and their mutual interactions. The sum of all S_i and S_{ij} less than one indicates that the effects of third and higher orders due to interactions are also present.

The presence of higher order interactions could dramatically complicate the determination of the effective approximate response function for the assessment of structural reliability (Bucher, Most 2008). The response surface method is based on the substitution of the limit state function with an approximation – the response surface. The function values of this approximation are determined more easily (Bucher, Most 2008). First or second order polynomials are commonly selected for these functions. The main motivation for the utilization of the

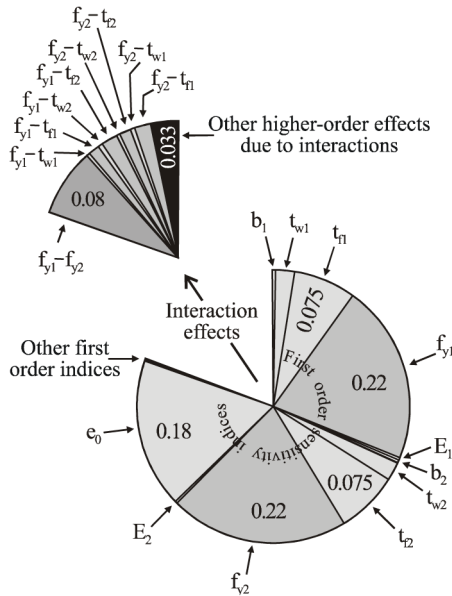

Fig. 6. Sensitivity analysis – Frame 1, $h = 3$ m

approximate response function is decrease in computational costs of structural reliability analysis. In this regard, the results of Sobol’s sensitivity analysis can be of great value for the compilation of the approximate response function.

Results of the sensitivity analyses of the frames for $h = 3$ m are displayed in Figures 6 and 7. The variability of the load carrying capacity of Frame 1 is most sensitive to the yield strength of the left f_{y1} or right f_{y2} column and their interaction effect $f_{y1}-f_{y2}$ expressed by index $S_{5,17} = 0.08$, see Figure 6. The variability of the load carrying capacity of Frame 2 is most sensitive to imperfection e_0 , see Figure 7. It is apparent from the pie charts that the interaction effects are more significant for Frame 1. Interaction effects of both frames are mainly related to the yield strength; it is also evident from the analysis of the total effect (Eqn (4)), see Figures 8 and 9. The result $S_{19} \approx S_{T19}$ shows that the involvement of imperfection e_0 in interactions with other imperfections is very little. The variability of the load carrying capacity of the frames is practically unaffected by the variability of material and geometrical characteristics of the cross beam.

Sensitivity indices of crucial imperfections are plotted in dependence on the height of the frames h , see Figures 10 and 11. The frame height was considered as the analysis parameter with a step of 0.1 m. All sensitivity indices (Eqn (1)) and (Eqn (2)) were evaluated in each step. The varying effect of the amplitude of system imperfection e_0 on the load carrying capacity of the frames is evident. For Frame 1, e_0 has a maximal effect on the load carrying capacity when $h = 9.09$ m. The influence of other imperfections in this case is totally covered by e_0 . The top of the sensitivity index e_0 was obtained by the approximation of three points at the peak of the curve in Figure 10 by a quadratic parabola.

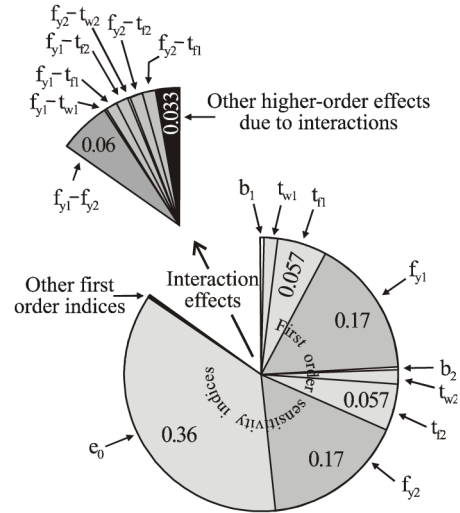

Fig. 7. Sensitivity analysis – Frame 2, $h = 3$ m

The results in Figure 10 provide new information which may be used for the determination of probability of failure in the probabilistic assessment of reliability. If $h < 9.09$ m, then the influence of yield strength and thickness of the flanges of the columns increases with decreasing frame height. On the contrary, if $h > 9.09$ m, then the influence of Young’s modulus and thickness of the flanges of the columns increase with increasing frame height. Higher-order interaction effects associated with the yield strengths of the columns are maximal if $h \rightarrow 0$.

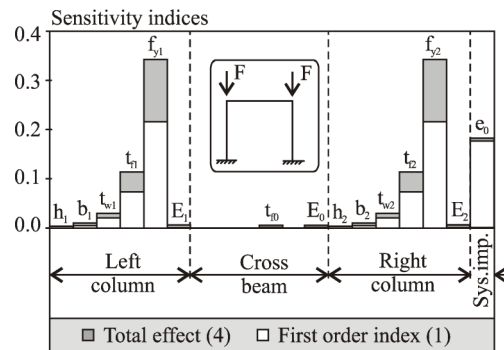

Fig. 8. Total sensitivity analysis – Frame 1, $h = 3$ m

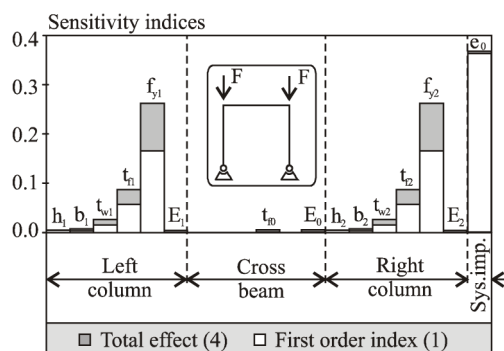

Fig. 9. Total sensitivity analysis – Frame 2, $h = 3$ m

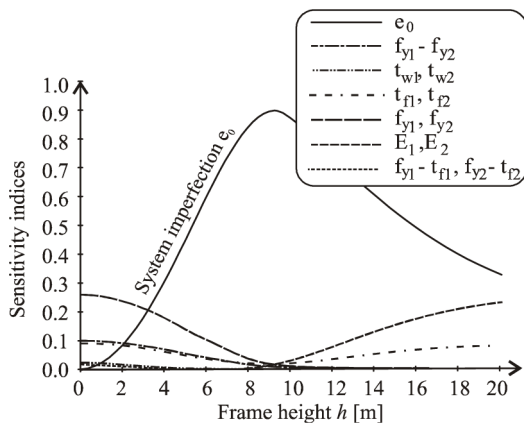

Fig. 10. Sensitivity analysis – Frame 1

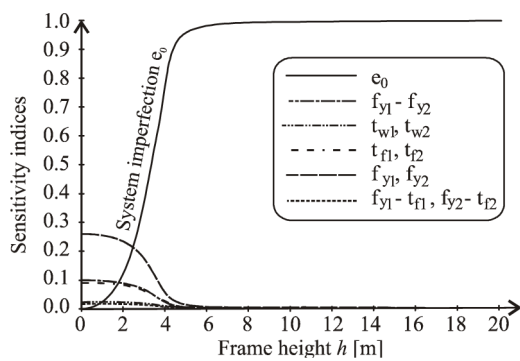

Fig. 11. Sensitivity analysis – Frame 2

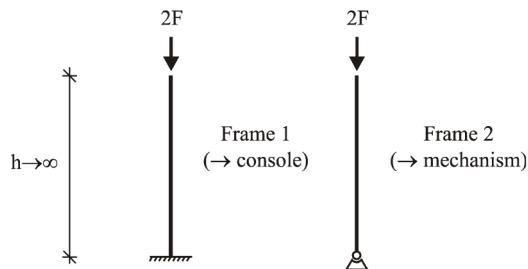

Fig. 12. Computational models for the frames with $h \rightarrow \infty$

Conclusions

Sensitivity analysis results of the load carrying capacities of two symmetric portal frames are published in this article. The obtained results of the sensitivity analyses point out the imperfections the variability of which can have an effect on the reliability of the structure. It has been demonstrated that the effects of imperfections on the load carrying capacity vary dramatically according to the boundary conditions of the end conditions of the columns.

In the case of hinged column ends (Frame 2), the sensitivity of the load carrying capacity to the variability of the amplitude of initial system imperfection e_0 increases with increasing frame height. With increasing height

h , Frame 2 becomes increasingly unstable and becomes a mechanism. Perfect Frame 2 becomes a mechanism when $h \rightarrow \infty$, see Figure 12. Real Frame 2 becomes very sensitive to the amplitude of system geometric imperfection e_0 if $h > 5$. For $h > 5$, material and geometric characteristics, apart from the amplitude of system imperfection e_0 , have no effect on the load carrying capacity. This is an important finding for ensuring the safety and reliability of such systems.

If the column ends are fixed (Frame 1), then the increase in the frame height increases the sensitivity of the load carrying capacity to the variability of the amplitude of initial system imperfections e_0 till $h = 9.09$ m. When $h = 9.09$ m then the sensitivity of the load carrying capacity to e_0 is maximal. If $h > 9.09$ m, then the sensitivity of the load carrying capacity to e_0 decreases with increasing h . If the frame height (column slenderness) increases further, then the load carrying capacity approaches the Euler buckling load. Euler buckling load of perfect Frame 1 is a function of Young's modulus, geometric characteristics of the cross sections and buckling lengths of the columns, but is not a function of e_0 or the yield strength f_y , which is reflected in the changes in values of the relevant sensitivity coefficients.

If $h \rightarrow 0$, the sensitivity analysis results of Frame 1 and Frame 2 are the same. The load carrying capacities of the frames are most sensitive to the variability of yield strengths f_{y1} and f_{y2} of the columns. Interaction $f_{y1} \cdot f_{y2}$ also significantly influences the load carrying capacity, if $h = 0$, then $S_{5,17} = 0.1$. Interaction $f_{y1} \cdot f_{y2}$ means that the extreme values of the load carrying capacity are clearly associated with certain combinations of inputs f_{y1}, f_{y2} of the model in a manner not expressed by the first-order effects S_5 and S_{17} . Identification of interaction effects can be very useful for the proposal of simple and effective approximate response functions (Bucher, Most 2008). It has been illustrated in the presented article that interaction occurs only among certain imperfections, while it can be completely neglected for other imperfections. This makes it possible to consider only the absolutely necessary number of interaction terms in the approximate response functions, which can then be effectively utilized for the realization of a high number of simulation runs of the Monte Carlo method.

Model complexity can be constrained by eliminating imperfections when sensitivity analyses show that they do not significantly affect the load carrying capacity and when there is no reason to consider their random variability. This applies to the imperfection of the cross beam the variability of which does not influence the load carrying capacity and can be considered in stochastic models as deterministic (non-random).

Acknowledgements

This work was supported by the Czech Science Foundation GACR (Grantová agentura České republiky) under Grant GAČR 14-17997S.

References

- Agüero, A.; Pallarés, L.; Pallarés, F. J. 2015. Equivalent geometric imperfection definition in steel structures sensitive to flexural and/or torsional buckling due to compression, *Engineering Structures* 96: 160–177. <http://dx.doi.org/10.1016/j.engstruct.2015.03.065>
- Antucheviciene, J.; Kala, Z.; Marzouk, M.; Vaidogas, E. R. 2015. Solving civil engineering problems by means of fuzzy and stochastic MSDM methods: current state and future research, *Mathematical Problems in Engineering* 2015: 16 p. <http://dx.doi.org/10.1155/2015/362579>
- Bažant, Z.; Cedolin, L. 1991. *Stability of structures: elastic, inelastic, fracture and damage theories*. New York-Oxford: Oxford University Press. 1011 p.
- Beaulieu, D.; Adams, P. F. 1977. A statistical approach to the problem of stability related to structural out-of-plumb, in *Proc. of the International Colloquium on Stability of Structures under Static and Dynamic Loads*, May 1977, Washington, D.C., USA, 114–121.
- Bucher, C.; Most, T. 2008. A comparison of approximate response functions in structural reliability analysis, *Probabilistic Engineering Mechanics* 23(2–3): 154–163. <http://dx.doi.org/10.1016/j.probengmech.2007.12.022>
- Dario Aristizabal-Ochoa, J. 2013. Stability of multi-column systems with initial imperfections and non-linear connections, *International Journal of Non-Linear Mechanics* 57: 75–89. <http://dx.doi.org/10.1016/j.ijnonlinmec.2013.06.012>
- Dario Aristizabal-Ochoa, J. 2015. Stability of imperfect columns with nonlinear connections under eccentric axial loads including shear effects, *International Journal of Mechanical Sciences* 90: 61–76. <http://dx.doi.org/10.1016/j.ijmecsci.2014.11.005>
- EN 1090-2:2008+A1:2011. *Eurocode – Execution of steel structures and aluminium structures – Part 2: Technical requirements for steel structures*. CEN, Brussels, Belgium, 2011. 209 p.
- EN 1993-1-1:2005. *Eurocode 3 – design of steel structures: general rules and rules for buildings*. CEN, Brussels, Belgium, 2005. 102 p.
- Chan, S. L.; Zhou, Z. H. 1995. 2nd-order elastic analysis of frames using single imperfect element per member, *Journal of Structural Engineering ASCE* 121(6): 939–945. [http://dx.doi.org/10.1061/\(ASCE\)0733-9445\(1995\)121:6\(939\)](http://dx.doi.org/10.1061/(ASCE)0733-9445(1995)121:6(939))
- Iman, R. C.; Conover, W. J. 1980. Small sample sensitivity analysis techniques for computer models with an application to risk assessment, *Communications in Statistics – Theory and Methods* 9(17): 1749–842. <http://dx.doi.org/10.1080/03610928008827996>
- Kala, Z. 2008. Sensitivity analysis of carrying capacity of steel plane frames to imperfections, in *Proc. of the 6th International Conference on Numerical Analysis and Applied Mathematics (ICNAAM 2008)*, 16–20 September 2008, Rodos, Greece, 298–301. <http://dx.doi.org/10.1063/1.2990917>
- Kala, Z. 2009. Sensitivity assessment of steel members under compression, *Engineering Structures* 31(6): 1344–1348. <http://dx.doi.org/10.1016/j.engstruct.2008.04.001>
- Kala, Z. 2011a. Sensitivity analysis of stability problems of steel plane frames, *Thin-Walled Structures* 49(5): 645–651. <http://dx.doi.org/10.1016/j.tws.2010.09.006>
- Kala, Z. 2011b. Sensitivity analysis of steel plane frames with initial imperfections, *Engineering Structures* 33(8): 2342–2349. <http://dx.doi.org/10.1016/j.engstruct.2011.04.007>
- Kala, Z. 2012. Geometrically non-linear finite element reliability analysis of steel plane frames with initial imperfections, *Journal of Civil Engineering and Management* 18(1): 81–90. <http://dx.doi.org/10.3846/13923730.2012.655306>
- Kala, Z. 2015. Reliability analysis of the lateral torsional buckling resistance and the ultimate limit state of steel beams with random imperfections, *Journal of Civil Engineering and Management* 21(7): 902–911. <http://dx.doi.org/10.3846/13923730.2014.971130>
- Kala, Z.; Puklický, L. 2009. Sensitivity analysis of carrying capacity of steel plane frames to imperfections, in *Proc. of the International Conference Computational Structural Engineering*, 22–24 June 2009, Shanghai, China, 991–997. http://dx.doi.org/10.1007/978-90-481-2822-8_111
- Kala, Z.; Melcher, J.; Puklický, L. 2009. Material and geometrical characteristics of structural steels based on statistical analysis of metallurgical products, *Journal of Civil Engineering and Management* 15(3): 299–307. <http://dx.doi.org/10.3846/1392-3730.2009.15.299-307>
- Kamiński, M.; Świta, P. 2014. Structural stability and reliability of the underground steel tanks with the stochastic finite element method, *Archives of Civil and Mechanical Engineering* 15(2): 593–602. <http://dx.doi.org/10.1016/j.acme.2014.04.010>
- Kennedy, D. J. L.; Picard, A.; Beaulieu, D. 1993. Limit states design of beam-columns: the Canadian approach and some comparisons, *Journal of Constructional Steel Research* 25(1–2): 141–164. [http://dx.doi.org/10.1016/0143-974X\(93\)90056-X](http://dx.doi.org/10.1016/0143-974X(93)90056-X)
- Marčić, D.; Cerić, A.; Kovačević, M. S. 2013. Selection of a field testing method for karst rock mass deformability by multi criteria decision analysis, *Journal of Civil Engineering and Management* 19(2): 196–205. <http://dx.doi.org/10.3846/13923730.2012.743927>
- McKey, M. D.; Conover, W. J.; Beckman, R. J. 1979. A comparison of the three methods of selecting values of input variables in the analysis of output from a computer code, *Technometrics* 21(2): 239–245. <http://dx.doi.org/10.2307/1268522>
- Melcher, J.; Kala, Z.; Holický, M.; Fajkus, M.; Rozlívka, L. 2004. Design characteristics of structural steels based on statistical analysis of metallurgical products, *Journal of Constructional Steel Research* 60(3–5): 795–808. [http://dx.doi.org/10.1016/S0143-974X\(03\)00144-5](http://dx.doi.org/10.1016/S0143-974X(03)00144-5)
- Nagyová, M.; Ravinger, J. 2012. Stability and vibration of imperfect column, *Procedia Engineering* 40: 286–291. <http://dx.doi.org/10.1016/j.proeng.2012.07.095>
- Prasad, K.; Zavadskas, E. K.; Chakraborty, S. 2015. A software prototype for material handling equipment selection for construction sites, *Automation in Construction* 57: 120–131. <http://dx.doi.org/10.1016/j.autcon.2015.06.001>
- Saltelli, A.; Chan, K.; Scott, E. M. 2004. *Sensitivity analysis*. Wiley series in probability and statistics. New York: John Wiley and Sons. 475 p.
- Shayan, S.; Rasmussen, K. J. R.; Zhang, H. 2014. On the modeling of initial geometric imperfections of steel frames in advanced analysis, *Journal of Constructional Steel Research* 98: 167–177. <http://dx.doi.org/10.1016/j.jcsr.2014.02.016>
- Siozinyte, E.; Antucheviciene, J. 2013. Solving the problems of daylighting continuity in a reconstructed vernacular building, *Journal of Civil Engineering and Management* 19(6): 873–882. <http://dx.doi.org/10.3846/13923730.2013.851113>
- Soares, G. C. 1988. Uncertainty modelling in plate buckling, *Structural Safety* 5(1): 17–34. [http://dx.doi.org/10.1016/0167-4730\(88\)90003-3](http://dx.doi.org/10.1016/0167-4730(88)90003-3)
- Sobol', I. M. 1993. Sensitivity analysis for non-linear mathematical models, *Mathematical Modelling and Computational Experiment* 1: 407–414. Translated from Russian: I. M. Sobol'. 1990. Sensitivity estimates for nonlinear mathematical models, *Matematicheskoe Modelirovanie* 2: 112–118.

- Sobol', I. M. 2001. Global sensitivity indices for nonlinear mathematical models and their Monte Carlo estimates, *Mathematics and Computers in Simulation* 55(1–3): 271–280. [http://dx.doi.org/10.1016/S0378-4754\(00\)00270-6](http://dx.doi.org/10.1016/S0378-4754(00)00270-6)
- Sousa, R.; Guedes, J.; Sousa, H. 2015. Characterization of the uniaxial compression behaviour of unreinforced masonry – sensitivity analysis based on a numerical and experimental approach, *Archives of Civil and Mechanical Engineering* 15(2): 532–547. <http://dx.doi.org/10.1016/j.acme.2014.06.007>
- Xu, L.; Wang, X. H. 2008. Storey-based column effective length factors with accounting for initial geometric imperfections, *Engineering Structures* 30(12): 3434–3444. <http://dx.doi.org/10.1016/j.engstruct.2008.05.015>
- Yang, I. H. 2007. Uncertainty and sensitivity analysis of time-dependent effects in concrete structures, *Engineering Structures* 29(7): 1366–1374. <http://dx.doi.org/10.1016/j.engstruct.2006.07.015>
- Zhang, H.; Chandrangsou, T.; Rasmussen, K. J. R. 2010. Probabilistic study of the strength of steel scaffold systems, *Structural Safety* 32(6): 393–401. <http://dx.doi.org/10.1016/j.strusafe.2010.02.005>

Zdeněk KALA. Professor, PhD, Department of Structural Mechanics, Brno University of Technology, Faculty of Civil Engineering. Co-author of 14 books, 3 textbooks and more than 180 scientific papers (120 published abroad). Research interests: elastic-plastic analysis, stability problems, sensitivity analysis and optimization of steel and steel-concrete structures including material and geometrical non-linearities, numerical methods in structural mechanics, and reliability methods.